

➤ **Lica miniCMTS**

- aktuální portfolio
- připravujeme
- Samsung TV & vestavěný modem

➤ **Lica & Arris**

- kabelové modemy
- C4 – FW 8.3
- E6000 – karty 2. generace

Bc. Jakub Radoň  
email: [jakub.radon@lica.cz](mailto:jakub.radon@lica.cz)

# Lica miniCMTS - firmware

**Aktuální FW release: 3.89.15 & v665**

- **Velmi stabilní**
- **Interní DHCP + TFTP server** pro obsluhu kabelových modemů
- **US Spectrum Management** nově
- Podpora **IPTV Multicast**
- Podpora **IPQAM**
- **16DS bonding**
- Sítové režimy (Business modes) :
  - NONE (umožňuje také transport 802.1Q single tag)
  - Relay, Advanced Relay (DHCP Relay)
  - Option60, Bundle (VLAN tagování dle OPTION60)  
+ OPTION82 etc.
- Podpora **2000 DS klasifikátorů** pro DQoS – bude ukončena

## **Připravujeme**

- Opravy drobných chyb
- Ladění stávajících vlastností

# Lica miniCMTS – dostupné HW varianty



## LMC-1RU

- 16DS x 4US
- 1x DS port
- 1x US port
- 230V AC



## LMC-10U

- 16DS x 4US
- 1x VF vstup
- 1x VF výstup
- 48V AC



## LMC-2IU

- 16DS x 4US
- 2x VF vstup
- 2x VF výstup
- 12V DC  
(230V AC)



## LMC-2TU

- 16DS x 2US
- 2x VF vstup
- 2x VF výstup
- 230V AC

## Společné HW vlastnosti

- 2x 1G RJ45
- 1x 1G SFP

# Lica miniCMTS – připravujeme

## **EuroDOCSIS 3.0 32x8**

- 32x Downstream, 8x Upstream
- 10G SFP+, 1G RJ45
- 1RU provedení - na stánku.
- Jde o vývojovou verzi, prodej není plánován.



## **EuroDOCSIS 3.0 32x8 + DOCSIS 3.1**

- Navíc podpora DOCSIS 3.1.
- V plánu na rok 2018.
- HW provedení bude upřesněno.



# miniCMTS & SAMSUNG

- SAMSUNG TV řada HE694 „all-in-one“ s integrovaným kabelovým modemem EuroDOCSIS 3.0 – bonding 8x4.
- Pomocí DOCSIS umožňuje využít veškeré IP služby v TV, včetně **WiFi Hotspot**.
- Testy miniCMTS & SAMSUNG v LICA Czech byly **úspěšně dokončeny**.
- Nyní se dokončují testy v centrále Samsung pro certifikaci miniCMTS.
- Demo je vystaveno na stánku LICA Czech a SAMSUNG.

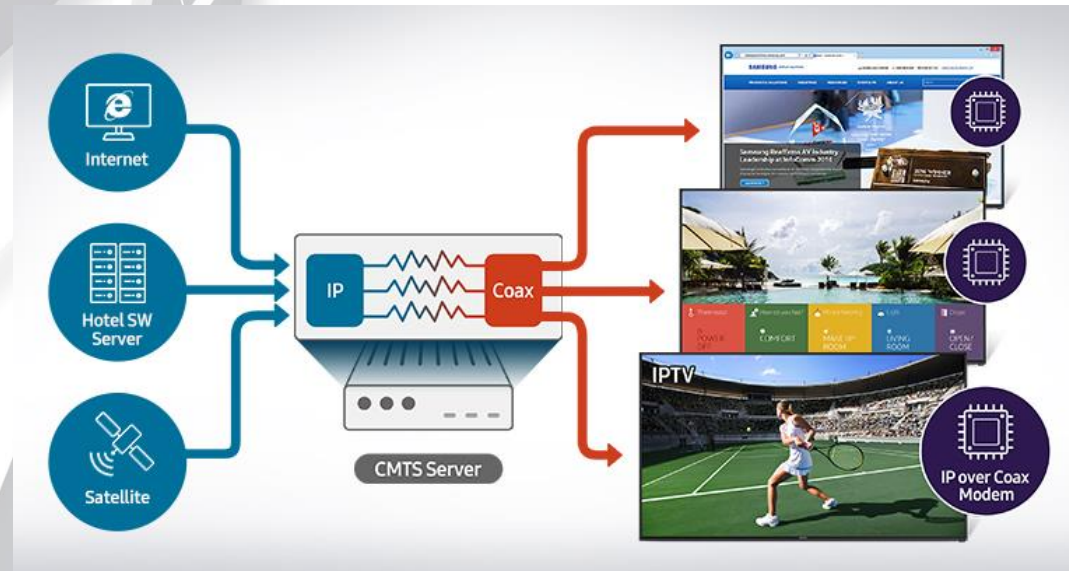



# ARRIS DOCSIS 3.0 and 3.1 SOLUTIONS

Generic and Bespoke product roadmap



# Touchstone<sup>®</sup> CM3200B-85/CE



## 32x8 EuroDOCSIS 3.0 Cable Modem



With full band tuners for enhanced flexibility.

### DOCSIS SUBSYSTEM

EuroDOCSIS 3.0 32x8  
Bonding  
Full capture bandwidth  
85 MHz diplexer

### SOFTWARE FEATURES

Supports IPv4 and IPv6  
Support for BSoD

### INDUSTRIAL DESIGN

Small form factor

### NETWORKING SUBSYSTEM

GigE port

### GENERAL FEATURES

Intel Puma 6  
External PSU

DOCSIS D/S → 1000 Mbps

DOCSIS U/S → 200 Mbps



Availability for delivery : NOW

# Touchstone® TG2492S-85/CE



24x8 EuroDOCSIS® 3.0 2-line Telephony Gate  
802.11ac Wi-Fi



Full band capture tuner for enhanced flexibility and smaller size

## DOCSIS SUBSYSTEM

EuroDOCSIS 3.0 24x8 Bonding  
Full capture bandwidth  
85 MHz diplexer

## SOFTWARE FEATURES

User friendly WebGUI  
Supports IPv4 and IPv6/DS-Lite  
Support for Hotpot/SoftGRE  
PC2.0, SIP and NCS support

## NETWORKING SUBSYSTEM

4 GigE port  
2x2:2 2.4GHz 802.11n  
3x3:3 5Ghz 802.11ac  
USB 2.0

## INDUSTRIAL DESIGN

Vertical design for improved Wi-Fi

## GENERAL FEATURES

Intel Dual Core Puma 6MG  
External PSU

Wi-Fi	1200 Mbps
DOCSIS D/S	1200 Mbps
USB 2.0	480 Mbps
DOCSIS U/S	200 Mbps



Availability for delivery : NOW





# Touchstone® TG3442S/CE

DOCSIS® 3.1 2-line Telephony Gateway with 802.11ac Wi-Fi



The TG3442S is a high-end, high-performance D3.1 gateway that targets premium subscribers



## DOCSIS SUBSYSTEM

DOCSIS 3.1 2x2  
EuroDOCSIS 3.0 32x8  
US 5MHz-85MHz/204MHz  
DS 108MHz/258MHz-1218Mhz

## NETWORKING SUBSYSTEM

4 GigE port  
3x3:3 2.4GHz 802.11n  
4x4:4 5Ghz 802.11ac Wave 2  
USB 3.0

## GENERAL FEATURES

Intel Dual Core Puma 7 (CE2752)  
External PSU

## SOFTWARE FEATURES

User friendly WebGUI  
Supports IPv4 and IPv6/DS-Lite  
Support for Hotpot/SoftGRE  
PC2.0, SIP and NCS support

## INDUSTRIAL DESIGN

Vertical design for improved Wi-Fi



# Touchstone® EuroDOCSIS 3.0 portfolio



	Cable Modem	Cable Modem	Telephony Modem
Product Name	CM820S/CE	CM3200B-85/CE	TM822S/CE
Description	DOCSIS3.0, CM	DOCSIS3.0, CM	DOCSIS3.0, 2-Line EMTA
Channel Bonding	8DS / 4US	32DS / 8US	8DS / 4US
US Diplexer	5-65 MHz	5-85 MHz	5-65 MHz
DOCSIS Silicon	Intel Puma 5	Intel Puma 6	Intel Puma 5
PacketCable Voice Support	n/a	n/a	NCS, SIP , PC2.0
Ethernet ports	1	1	1
Wireless LAN	n/a	n/a	n/a
Availability	NOW	NOW	NOW

# Touchstone® EuroDOCSIS 3.0 portfolio



	Telephony Gateway	Telephony Gateway
Product Name	TG1652S-85/CE	TG2492S-85/CE
Description	DOCSIS3.0, 2-Line Wireless Telephony Gateway	DOCSIS3.0, 2-Line Wireless Telephony Gateway
Channel Bonding	16DS / 4US	24DS / 8US
US Diplexer	5-85 MHz	5-85 MHz
DOCSIS Silicon	Intel Puma 6	Intel Puma 6MG
PacketCable Voice Support	NCS, SIP , PC2.0	NCS, SIP , PC2.0
Ethernet ports	4	4
Wireless LAN	Mediatek b/g/n 2x2:2@2.4GHz a/n/ac 2x2:2@5GHz	Qualcomm b/g/n 2x2:2@2.4GHz a/n/ac 3x3:3@5GHz
Availability	NOW	NOW

# Touchstone® European DOCSIS 3.1 portfolio



	Telephony Modem	Data Gateway	Telephony Gateway
Product Name	TM3402S/CE	DG3440S/CE	TG3442S/CE
Description	DOCSIS3.1 EMTA	DOCSIS3.1 Wireless Data Gateway	DOCSIS3.1 Wireless Telephony Gateway
Channel Bonding	32DS/8US – 2DS/2US	32DS/8US – 2DS/2US	32DS/8US – 2DS/2US
Diplexer	Switched	Switched	Switched
DOCSIS Silicon	Intel Puma 7 (CE2703)	Intel Puma 7 (CE2752)	Intel Puma 7 (CE2752)
PacketCable Voice Support	NCS, SIP , PC2.0	n/a	NCS, SIP , PC2.0
Ethernet ports	4 (LAG on 2)	4	4
USB	No	USB 3.0	USB 3.0
Wireless LAN	n/a	Celero b/g/n 3x3:3@2.4GHz a/n/ac 4x4:4@5GHz	Celero b/g/n 3x3:3@2.4GHz a/n/ac 4x4:4@5GHz
Availability	Samples Q3 2017	Samples Q1 2018	Samples Q4 2017

# C4 CMTS / C4c CMTS — Release 8.3 Features

## What's New

- Hitless Dynamic DS and US Bonded Modem Load Balancing (24U CAM)
- Hitless Bonded Modem Movement (24U CAM)
- Energy Management 1x1 Mode
- Additional OSSiv3 IPDR Schemas (CM US STATS and CM REG STATUS)
- DHCP Relay Option 82.9 Support for MSO Defined Text
- Upstream Channel Bonding (USCB) Graceful TCS Reduction
- Filter Group Text Descriptions
- IPv6 Device Classes
  - Subscriber Management Filtering by Device Class
  - Supports MTA / DVA, STB, and PS Classes

Availability
<b>Field Soak Ready:</b> • N/A
<b>General Availability:</b> • Available now (Rel. 8.3.1.2, Rel. 8.3.0.178, Rel. 8.3.0.177)



# ARRIS E6000<sup>®</sup> Updates for Lica

September 11th, 2017

ARRIS Confidential and Proprietary

The ARRIS product roadmaps contained herein are for discussion purposes only to demonstrate our thoughts behind the evolutionary development of the ARRIS product offerings. ARRIS is not obligated to develop the software or hardware with the features and functionality discussed in these materials.

The roadmaps are subject to change.

# E6000 Gen-2 CER Front View



## Router System Module (RSM2)

- Network-side interfaces off the front & rear PIC
- Packet switching for all CER traffic
- System control of chassis and user interfaces
- 1:1 redundancy for high availability
- 2 x 100GbE QSFP+ 2 x1/10GbE SFP+ on front
- 10x10 Gigabit Ethernet ports (SFP+) + 3 x 100GbE (QSFP) total

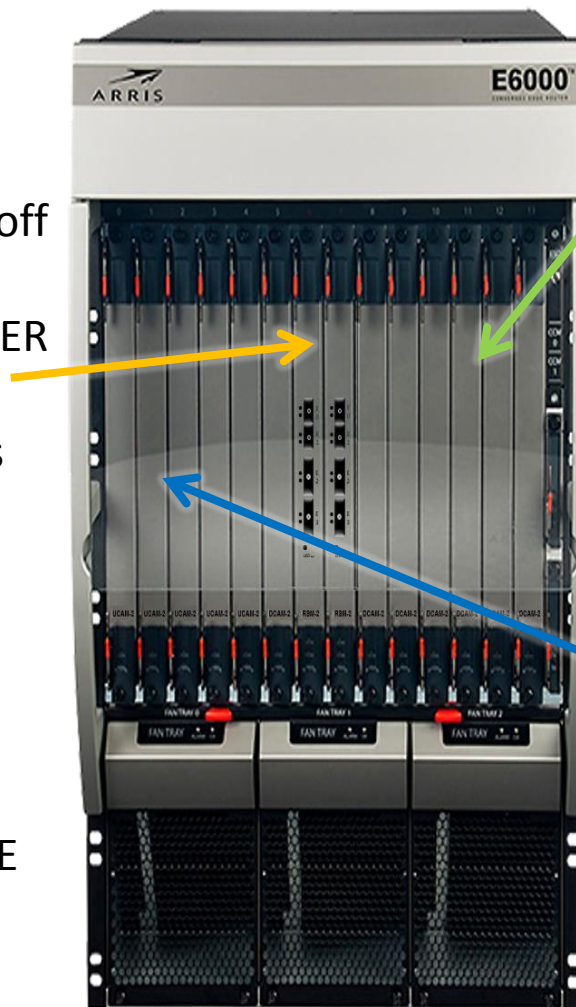

## Downstream CAM (DCAM2)

- 576 channel capacity (SC-QAMs) plus OFDM
- 36 SC-QAMs Annex A per MCX connector with 2 x 192 MHz OFDM
- Hitless sparing up to 7+1
- RF output spans from 50 MHz to 1.2 GHz

## Upstream CAM (UCAM2)

- 288 receivers per UCAM (licensable as 48, 72, 96, ..288 in incr of 1 Ch) + 2 OFDMA
- Each receiver capable of 5-204 MHz operation
- Hitless sparing up to 6+1

# E6000 CER Rear View

## DCAM Physical Interface Card (DPIC2)

- 16 MCX-connectors DCAM2 (gen-2)
- Spare in highest numbered slot

## Power Entry Modules (PEMs)

- Two -48V DC feeds per PEM (100A)
- Hitless failover between PEMs

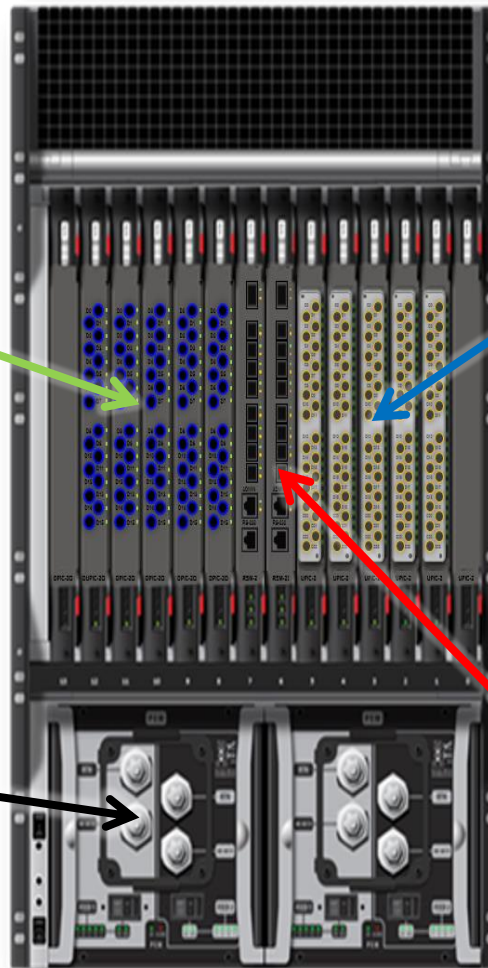

## UCAM Physical Interface Card (UPIC2)

- 24 MCX-Connectors per UCAM (in rear)
- Spare in lowest numbered slot

## RSM2 Physical Interface Card (RPIC-2Q)

- 1 x 100GbE QSFP28 + 8 x 10GbE SFP+
- 10/1000 BaseT OOB management Port
- Craft Interface



# NC2000 R-PHY Node



- **ARRIS R-PHY solution based on the NC2000 R-PHY node:**
  - Full 1.2GHz and 204MHz spectrum capable
  - RPD R-PHY module with support for a single upstream and downstream SG (i.e 1x1 segmentation)
  - 1.2 GHz RF Amplifier
    - Up to 2x2 60.5dBmV@1.2GHz/22dB tilt
- **E6000 CCAP Core with GEN-2 HW will support local SGs (I-CCAP) or remote SGs for R-PHY architectures:**
  - E6000 CER acts as the CCAP Core – MAC processing for all SGs
  - Common software and silicon components for all ARRIS R-PHY RPD solutions



Feature	NC2000
Dimensions (cm)	45.9 L x 26.3 W x 15 D
Volume (cubic cm)	18,107
Weight (kg)	~11.3
Thermal capacity	90W

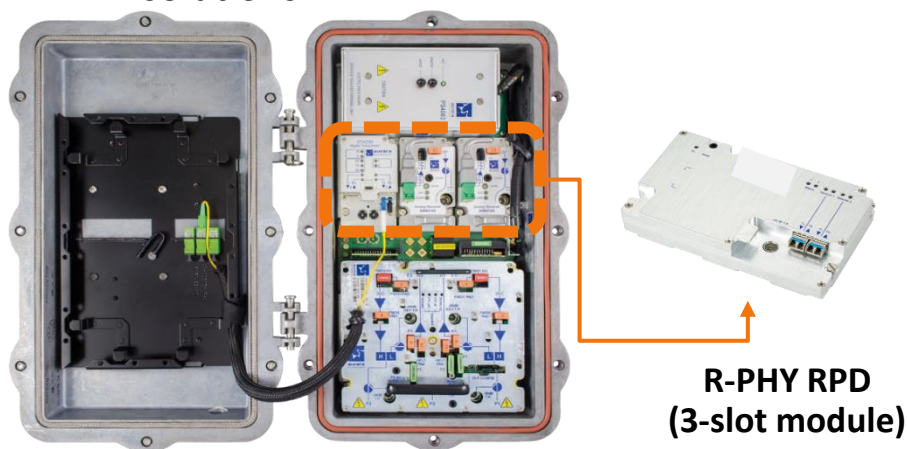

# ARRIS E6000 R-PHY Shelf



- 19" Rack-Mountable shelf, 2RU height, 10.4" (265mm) deep
- Temperature-hardened, front-to-back cooling, ready for cabinet installation
- Front connections for RF, SFP+, power
- Dual redundant AC or DC Power Supply Units (PSUs)
- 3x RPD modules currently planned (1x2 configuration each)
  - Total 3 DS-SG x 6 US-SG, full spectrum DOCSIS 3.0/3.1 (5x 192MHz blocks per DS-SG, 12x SC-QAM + 2x 96MHz OFDM per US-SG)
  - Each RPD module has dual SFP+, dual US-SG, DRFI levels
  - RPDs managed via E6000 CCAP Core
  - RF output level capability: 33/21 dBmV Real (1218/54 MHz) – Fiber Deep; tilt 12dB – 51.1 dBmV total composite power
- Samples available: 1Q/2018

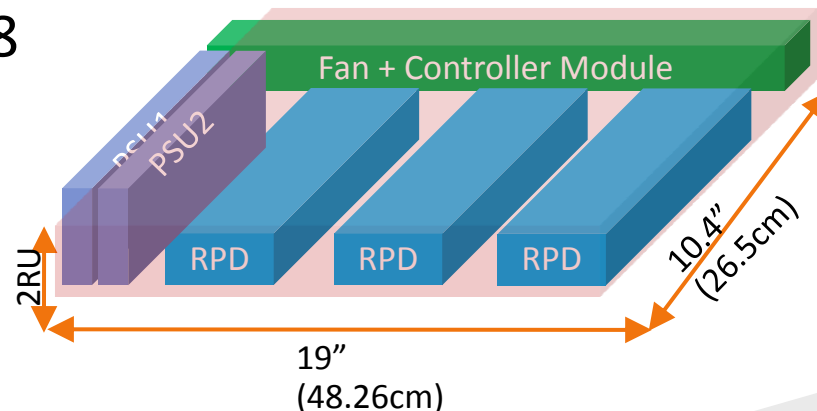

# E6000 10G EPON OLT

## Highlights

- IEEE 802.3-2012 compliant EPFM (EPON Fiber Module)
- High density
  - Up to 192 10G XFP EPON ports per chassis = 16 ports per EPFM X 12 EPFMs per chassis
- “Cable once”
  - with fiber connectors (SC) on rear PFM PIC
- DPoE V2.0 compliant
  - fully leverage DOCSIS back office
- SIEPON package A compliant
  - enabling 3rd party ONU interoperability
- Compliant with CCAP EPON requirements
- Fully leverages existing E6000 features



# E6000 Integrated DPoE V2.0

## DOCSIS Control Interface

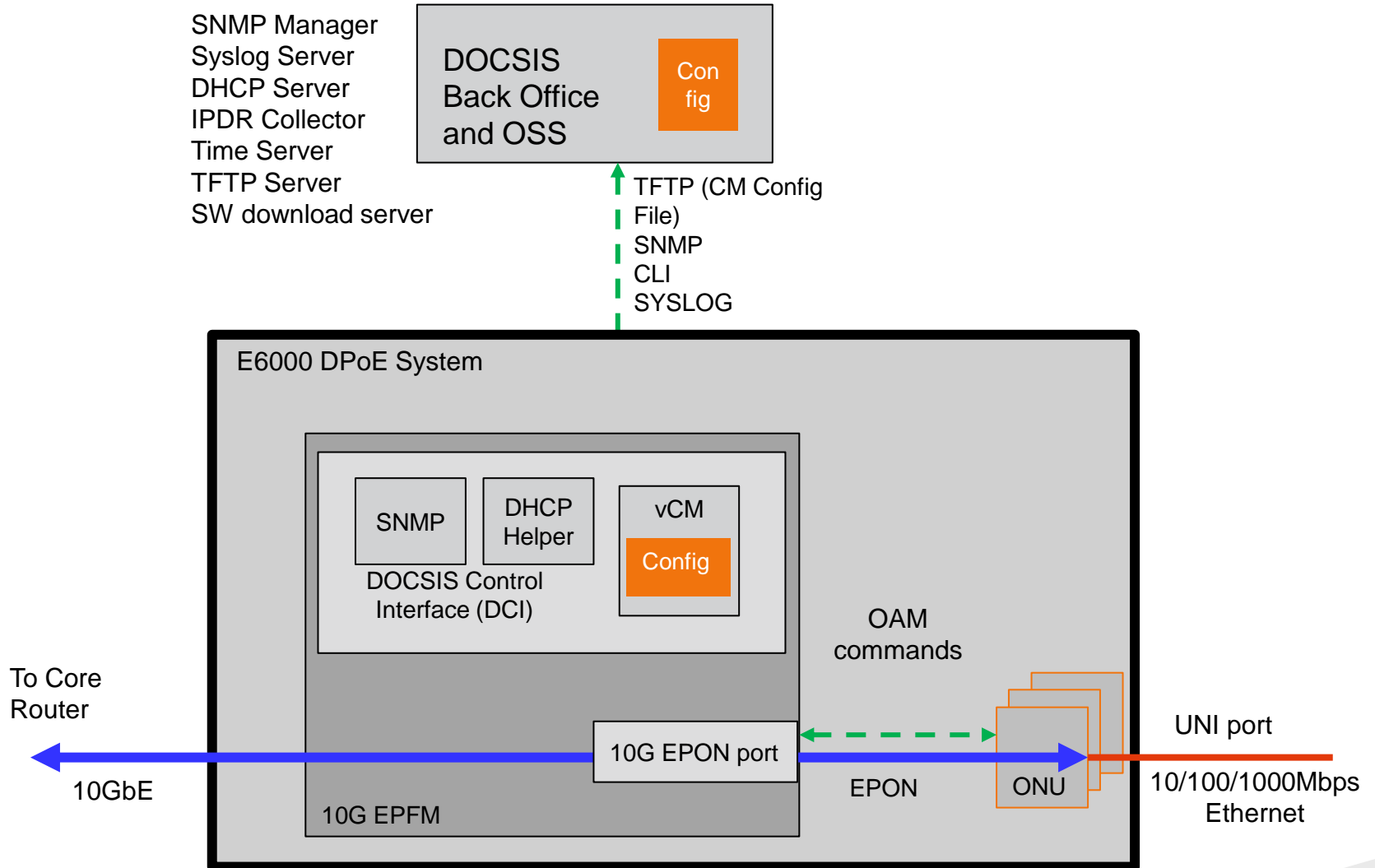

## NC4000 Node

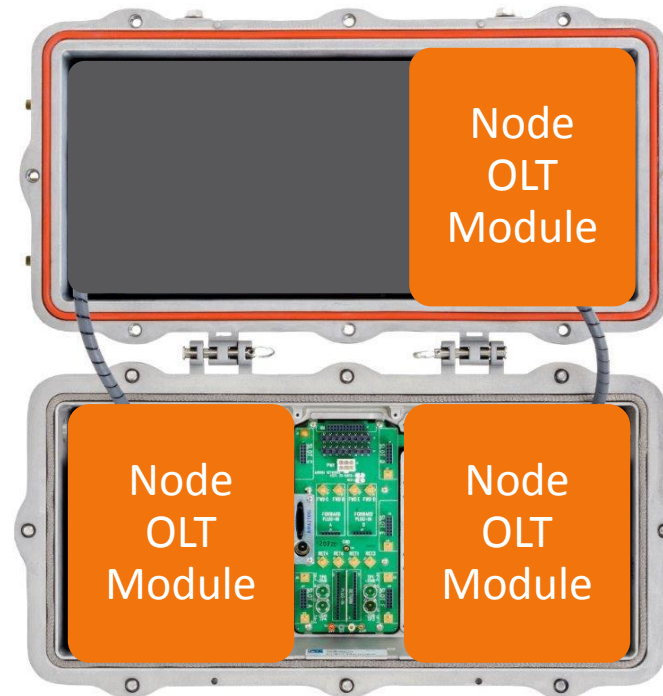

- Leverage existing, widely deployed, ARRIS platforms to support FTTH deployments
- Leverage E6000 10G EPFM hardware and software components for reduced time to market
- Support node based and small/medium chassis remote OLT applications

**Děkuji za pozornost**

Bc. Jakub Radoň  
email: [jakub.radon@lica.cz](mailto:jakub.radon@lica.cz)